

Elektrohydraulic Servovalves Typ HVM 067

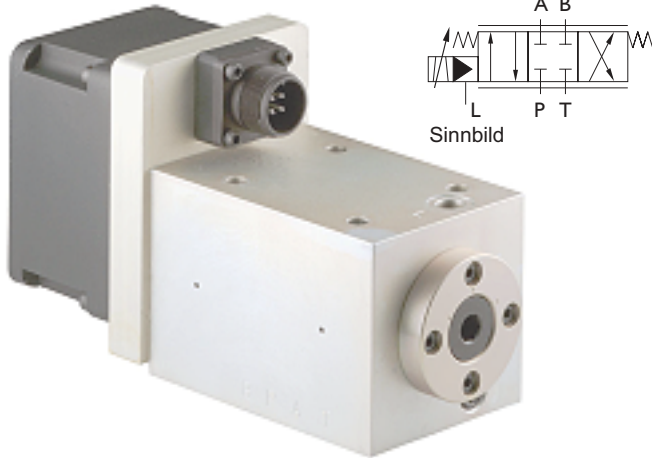

Special features:

- high reliability
- easy service
- robust construction
- high dynamic response
- relatively insensitive to contamination
- variable metering orifices only
- $Q_{max} = 100\text{l/min}$ at $\Delta p = 70\text{bar}$
- $p_N = 315\text{ bar}$
- Field of application plunger cylinder in differential operation (see application pattern)

General description:

Type	:	electrical input stage, torque motor, sliding spool system
Control main spool	:	torque motor actuated pilot spool located in 4-way sliding and correlated to the same
Style of mounting	:	sup-plate / Cetop 05
Mounting position	:	unrestricted
Weight	:	4,7kg

Technical Data

1. Hydraulic Data (definition according to DIN 24311)

.1	rated pressure	p_N	=	210	[bar]
.2	operating pressure	$p_{b \text{ min}}$	=	5	[bar]
		$p_{b \text{ max}}$	=	315	[bar]
.2.1	back stroke pressure	$p_{r \text{ max}}$	=	35 % p_b	
.3	max. pressure (static test pressure)	p_{max}	=	450	[bar]
.4	rated flow at $\Delta p = 70\text{ bar}$	Q_N	=	100	[l/min]
.5	quiescent flow, max. at p_N	Q_L	<	5% Q_N	
.6	internal max. leakage at $p_N = 210\text{ bar}$		<	50	[cm ³ /min]
.7	hysteresis	H	<	5% i_N 3% i_N	(without Dither) (with Dither)
.8	threshold sensitivity	E	<	0,7% i_N 0,2% i_N	(without Dither) (with Dither)
.9	threshold span	S	<	1,5% i_N 1% i_N	(without Dither) (with Dither)
.10	linearity deviation		<	10% i_N	
.11	flow symmetry - Q_N zu + Q_N		<	-10..+20% i_N	
.12	pressure gain (see diagram)	V_N	<	0,3 P_b / 1% i_N	
.13	overlap, standard	h	=	-1...+3% i_N	
.14	Bopeating temperature range	δ_M	=	253...353	[K]
.14.1	temperature drift		\geq	2% i_N / 50K	
.15	viscosity range of fluid	γ_{min}	=	10...1000 mm ² /s approximate value normal: ISO VG 10...ISO VG 46	
.16	filtration of fluid		<	10 μm	class 4-5 to NAS 1638 or SAE-ASTM
.17	fluid standard		=	HLP-hydraulic oils as per DIN 51524 Teil 2 (Special equipments possible)	

2. Diagrams HVM 067

Flow rate-signal function

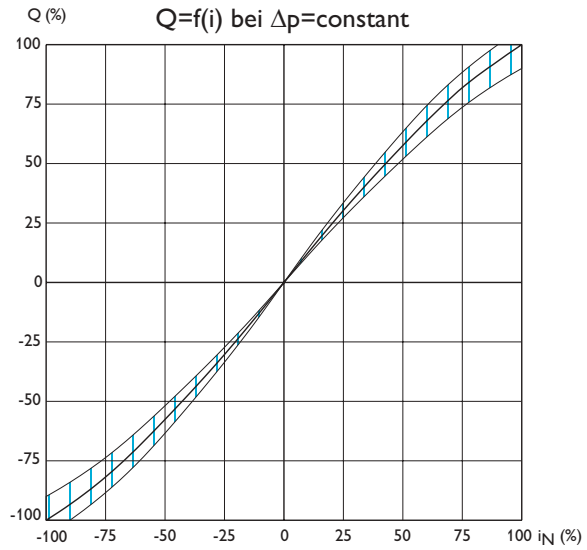

Pressure gain

$$V_p = \tan \alpha = \frac{\Delta p}{\Delta I}$$

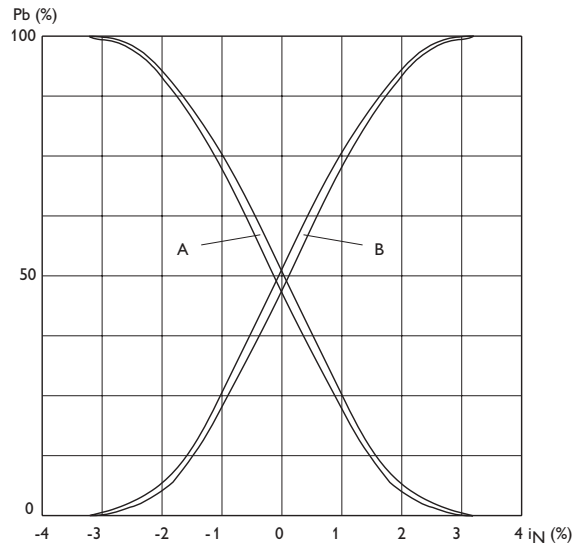

Frequency Response

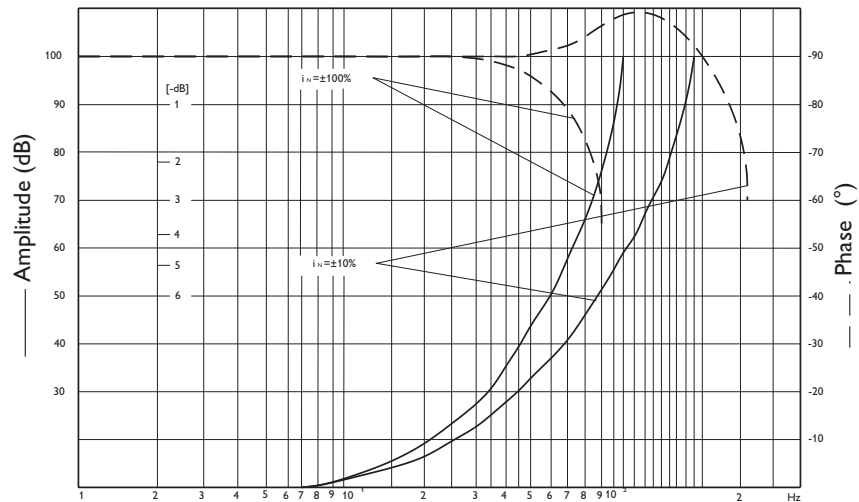

3. Electrical Data

3.1 Electrical Data without Electronic

A or C +V D or B 0V flow from P to B					Standard version coils parallel A+C: +V, D+B: 0V flow from P to B			Special equipment Coils serially A: +V, B: 0V flow from P to B			Special equipment A, B to C > A, B to D: flow from P to A		
coil type	inductance / coil	rated current	resistance	power	rated current	resistance	power	rated current	resistance	power	rated current	resistance	power
1	86 mH	± 325 mA	11,5Ω	1,35 W	± 650 mA	6 Ω	2,7 W	± 325 mA	23 Ω	2,7 W	650 mA	11,5Ω	5,4 W
2	320 mH	± 150 mA	60 Ω	1,35 W	± 300 mA	30 Ω	2,7 W	± 150 mA	120 Ω	2,7 W	300 mA	60 Ω	5,4 W

.2.1 Electrical Data with Electronic

Power supply:	24V DC (18V ... 28V)
Current:	350mA max.
Input signal:	-10V ... 0,0 ... +10V
Input resistance:	100 kohm
Signal direction:	from Pin D to Pin E
Internal coil current:	300mA ... 0mA ... -300mA
Test signal output:	3Volt ... 0V ... -3 Volt
Valve oil flow:	100% ... 0% ... -100%
Flow direction:	+10V = P > B und A > T 0,0V = Valve closed -10V = P > A und B > T

.2.2 Bloc diagram

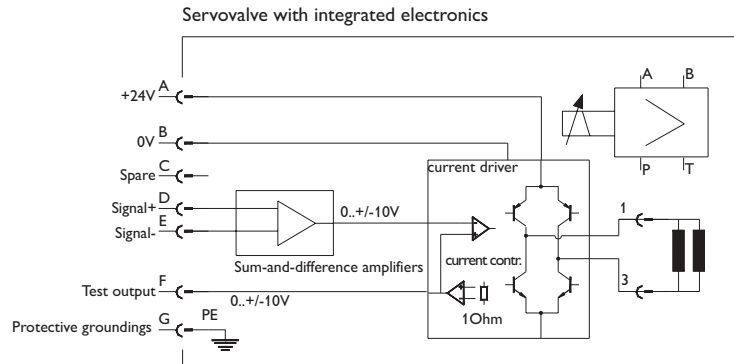

Reminds:

To avoid potential drifting problems, connect Pin E with low resistance (< 10 ohm) to Pin B.
 The electrical-hydraulic working direction can be changed to reversed connection on Pin D and Pin E

Cable recommendation:

twisted pair cable up to cable length 25 mtr.:
 Type LiYCY 3x2x0,5 mm² or LiYCY4x2X0,5mm², if you will use the test signal out.
 up to cable length 200 mtr.:
 Type LiYCY 3x2x0,75 mm² or LiYCY 4x2x 0,75 mm², if you will use the test signal out.

connector 7 pol.
 DIN 43563

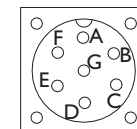

View on the valve
 Pins visible

Order Information

HVM 067 - 120 - 1200 - XX - LT- E1

<u>Model</u>	
067	
<u>Rated flow</u>	
Q _N at Δp =70 bar	
060 l/min	
080 l/min	
100 l/min	
120 l/min	
<u>Seal material</u>	
1 Perbunan	
2 Viton	
3 Butyl	
4 Vulkollan	
5 Ethylen-Propylen	
<u>Resistance / coil [R20]</u>	
1 11 Ω	
2 60 Ω	
<u>Overlap</u>	
0 Zero overlap	
1 Positiv overlap	
2 Negativ overlap	
<u>Amount of overlap</u>	
positive oder negative	
1..9	
<u>Design letter</u>	
assigned by manufacturer	
<u>Leakage</u>	
XX Standard Leakage extern	
LT Leakage intern	
<u>Elektronic</u>	
E1 Voltage input ±10V	
E2 Current input 4...20mA P nach A	
E3 Current input 4...20mA P nach B	
E4 Current input ±10mA	
E5 Current input ±20mA	

5. Accessories:

Description			Order No.
Connector	4pol.	KE CA 06 COM 14S 2S	13018
Connector	7pol.	KE CA 06 COM 14S 7S	21855
Sub plate	NG 10	HZ 036	39671
scavenger plate	NG 10	HZ 061	39686
Box-Amplifier		BOE XXX-025-0-5-0A	46965

Important remarks:

Valve mounting surface must be flat within 0,02mm and smoothness not to exceed 6µm. Easy hydraulic Zero adjustment by means of Allen key S8 DIN 911. Max. permissible drain line pressure 10 bar. Valves with modified characteristics available. Modifications, which serve technical progress, remain reserving.

status 1/2005

Für diese Vorlage bzw. Vorschrift techn. Art behalten wir uns alle Rechte vor. All rights reserved for this document (vgl. DIN 34)

- A 24 VDC ; 400 mA
- B 0 V
- C Signal 0
- D ± 10 V
- E 0 V
- F Feedback
- G PE ≡

Sechskantschraubendreher
DIN 911 s8 zum Justieren
des hydr. Nullpunkt
Justagebereich ± 45°

ISO 4401-05-04

Platzbedarf f Kabeldose
7 polig gerade DIN 43563

Gehäusestecker
7 polig DIN 43563

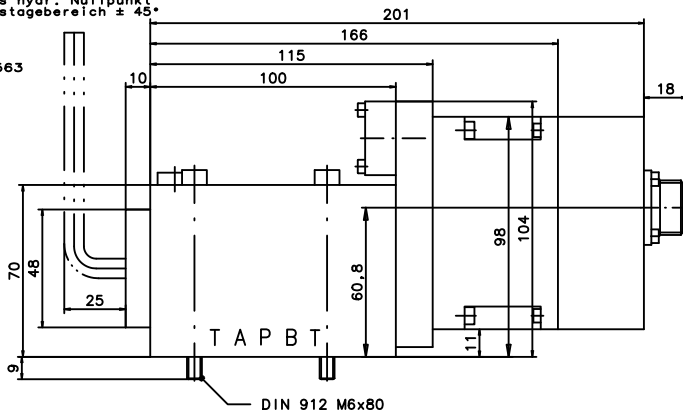
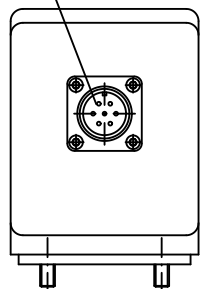

Einstellpotis Ventilelektronik

- ~F: Ditherfrequenz
- I: Nennstrom
- ~A: Ditheramplitude
- 0: Nullpunkt

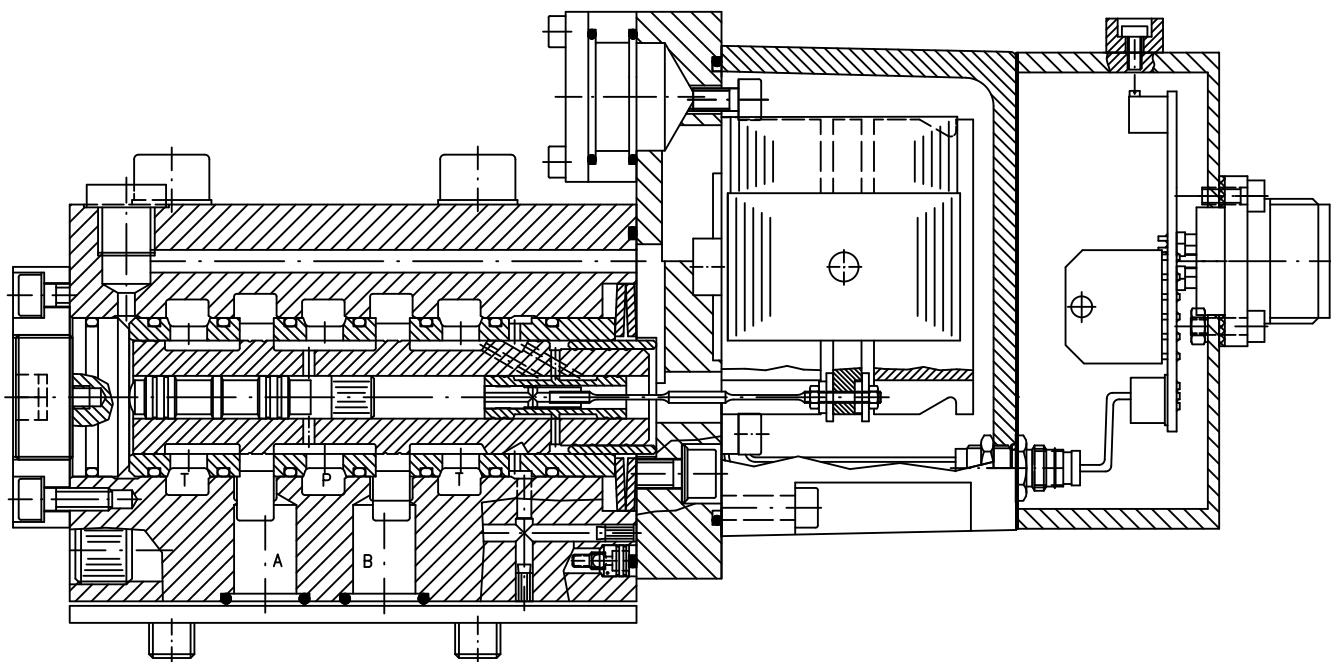

Angaben ohne Einheiten in mm
All dimensions without unit in mm

Nur zur Information / Only for information

Änderungsindex / Amendment index

Ventil
Valve

Id.- Nr.

HVM 067-XXX-XXXX-XX-LT-EX

dwg. 15.10.03 Dindorf

Jos. Schneider Optische Werke GmbH
Ringstr. 132 55543 Bad Kreuznach
Germany



Für diese Vorlage bzw. Vorschrift techn. Art behalten wir uns alle Rechte vor. All rights reserved for this document (vgl. DIN 34)

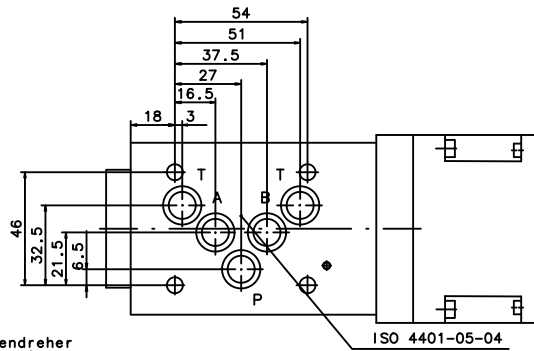

Sechskantschraubendreher
DIN 911 s8 zum Justieren
des hydr. Nullpunkt
Justagebereich $\pm 45^\circ$

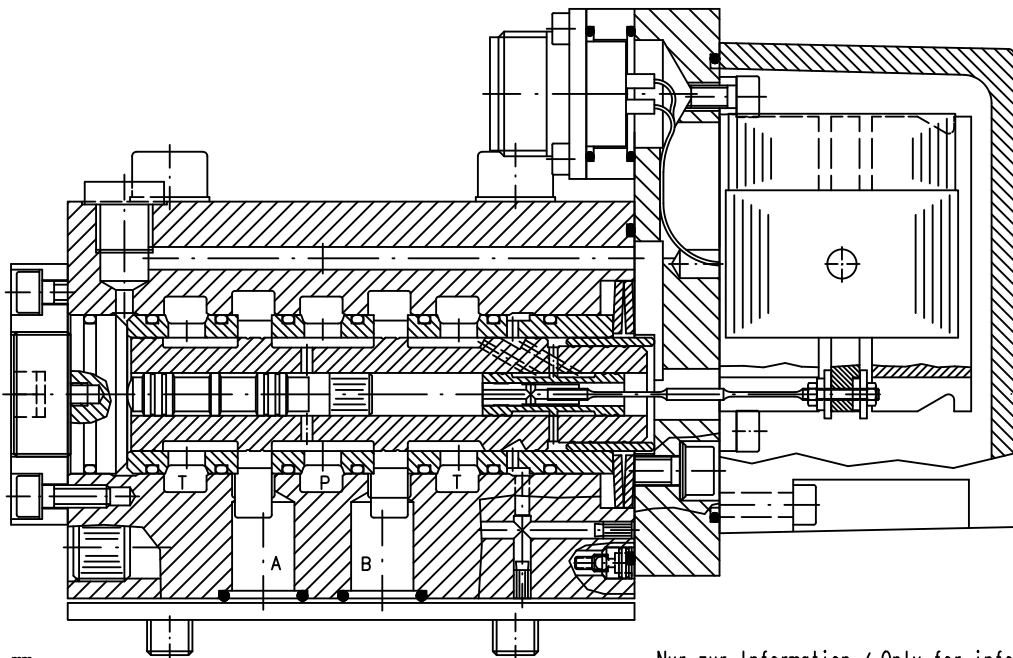
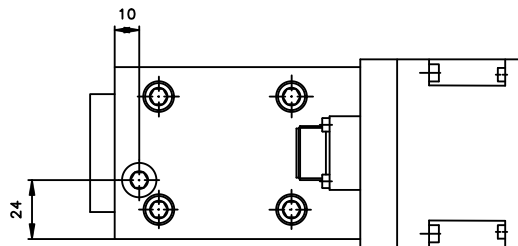
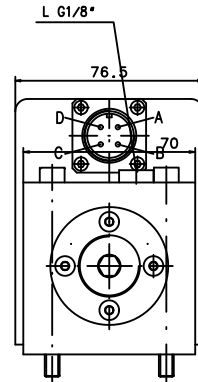
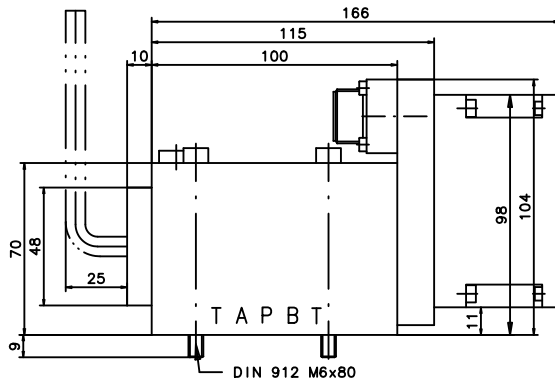

Angaben ohne Einheiten in mm
All dimensions without unit in mm

Nur zur Information / Only for information

Änderungsindex / Amendment index		
-		
Datum Date	Name Name	
dwg.	15.10.03	Dindorf

Ventil
Valve
HVM 067-XXX-XXXX-XX-LT

Id.- Nr.
-

Jos. Schneider Optische Werke GmbH
Ringstr. 132 55543 Bad Kreuznach
Germany

